



SECTION - H - INDEX

PAGE NUMBER

RED OAK STAIR PARTS

NEWELS	H-2
BALUSTERS	H-2
NEWEL AND BALUSTER DRAWINGS	H-3
RAIL AND FITTING DRAWINGS	H-4
COLONIAL RAIL / PLOWED RAIL	H-5
HANDRAIL AND WALLRAIL	H-5
PLOWED SHOE RAIL	H-5
RAIL FITTINGS	H-5
RAIL FITTINGS	H-6
RAIL FITTINGS DRAWINGS	H-7
HARDWARE, STEPS, AND ACCESSORIES DRAWINGS	H-8
BALUSTER AND NEWEL HARDWARE	H-9
ROSETTES	H-9
STARTING STEPS	H-9
FALSE TREADS & RISERS	H-9
STAIR BRACKETS	H-9
MOULDING	H-9

PAINT GRADE STAIR PARTS

NEWELS	H-10
RAILS	H-10
ROSETTES	H-10
BALUSTERS	H-10
PAINT GRADE STAIR PARTS DRAWINGS	H-11

IRON STAIR PARTS

BALUSTERS	H-12
BALUSTER ACCESSORIES	H-12
IRON STAIR PART DRAWINGS	H-13

RED OAK TREADS AND RISERS	H-14
RED OAK RETRO TREADS WHITE	H-14
OAK TREADS AND RISERS PINE	H-15
TREADS AND RISERS	H-16
TREAD DRAWINGS	H-17
OPEN FOR NOTES	H-18



Creative Stair Parts Brochure



Young Manufacturing red and white oak treads



Red Oak Stair Parts

By Southwest Mouldings

Oak Newels

(for post to post SW-6010 or SW-6010-P rail systems)

SW-4040	3" x 48" Starting Newel	ea.	\$59.00
SW-4042	3" x 54" Starting Newel	ea.	\$70.70
SW-4045	3" x 62" Landing Newel	ea.	\$79.70
SW-4055	3" x 72" Intermediate Newel	ea.	\$108.70

Oak Newels

(for over the post SW-6010 or SW-6010-P rail systems)

SW-4010	3" x 43" Starting Newel	ea.	\$57.70
SW-4093	3" X 48" Volute/Turnout Newel	ea.	\$71.30
SW-4015	3" x 62" Landing Newel	ea.	\$82.80
SW-4017	3" x 72" Landing Newel	(Discontinued)	ea. \$90.00

Oak Box Newels

SW-4075	3 1/2" x 63 3/4" Landing Newel	ea.	\$133.30
SW-4075SL	4-1/2" x 22-1/8" Sleeve for 4075 Newel	ea.	\$81.50
SW-4091	5 1/2" x 55" Plain Newel	ea.	\$168.80
SW-4091-F	5 1/2" x 55" Fluted Newel	ea.	\$190.90
SW-4091-XLF	6 1/4" x 55" Fluted Newel	ea.	\$221.10

Oak Balusters

(for SW-6010 or SW-6010-P rail systems)

SW-5015	1 1/4" x 31" Colonial	(Discontinued)	ea.	\$8.60
	1 1/4" x 34" Same		ea.	\$9.20
	1 1/4" x 36" "		ea.	\$9.60
	1 1/4" x 39" "		ea.	\$10.70
	1 1/4" x 41" "		ea.	\$11.10
SW-5067	1 1/4" x 31" Turned Center	(Discontinued)	ea.	\$9.30
	1 1/4" x 34" Same		ea.	\$9.70
	1 1/4" x 36" "		ea.	\$10.30
	1 1/4" x 39" "		ea.	\$10.10
	1 1/4" x 41" "		ea.	\$11.00



POST TO POST NEWELS

BOX NEWELS

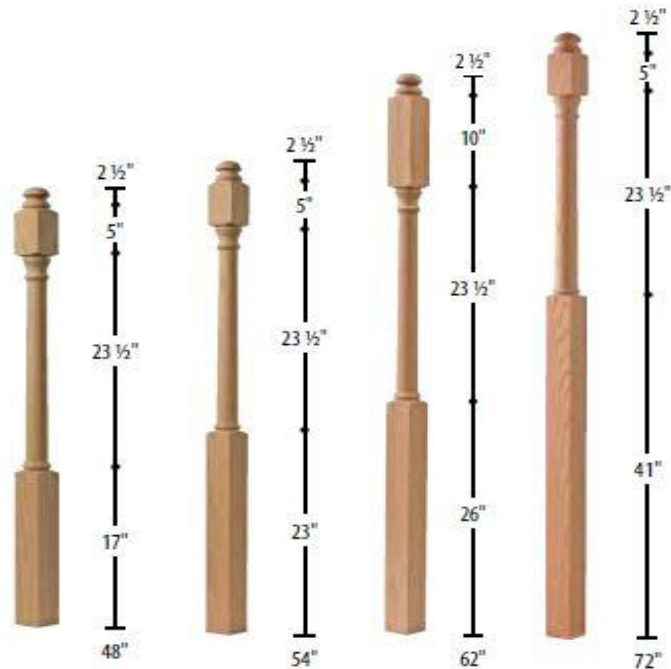

SW-4004 Oak 3" x 48" Starting Newel
 SW-4042 Oak 3" x 54" Starting Newel
 SW-4045 Oak 3" x 62" Landing Newel
 SW-4055 Oak 3" x 72" Landing Newel

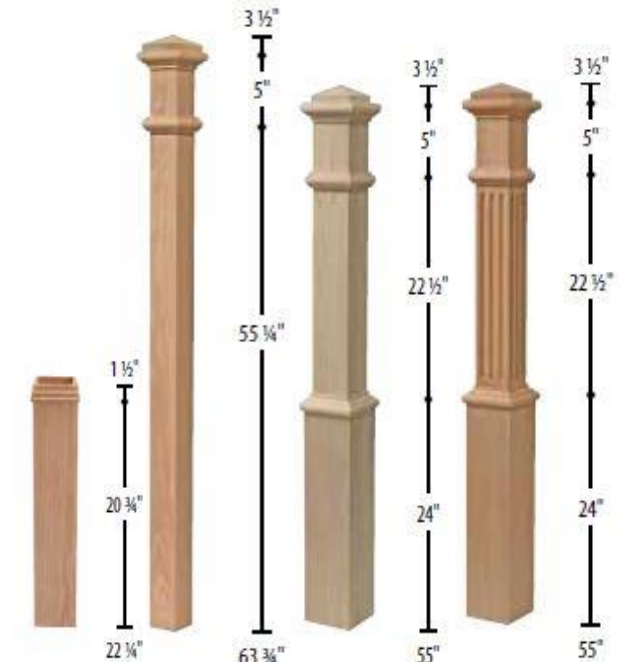

SW-4075SL 22 1/4" Starting Newel
 SW-4075 20 3/4" Starting Newel
 SW-4091 63 3/4" Starting Newel
 SW-4091F 5-1/2" & SW-4091XLF 6-1/4" Starting Newel
 SW-4091F 22 1/2" Landing Newel
 SW-4091XLF 22 1/2" Landing Newel

OVER THE POST NEWEL

BALUSTERS

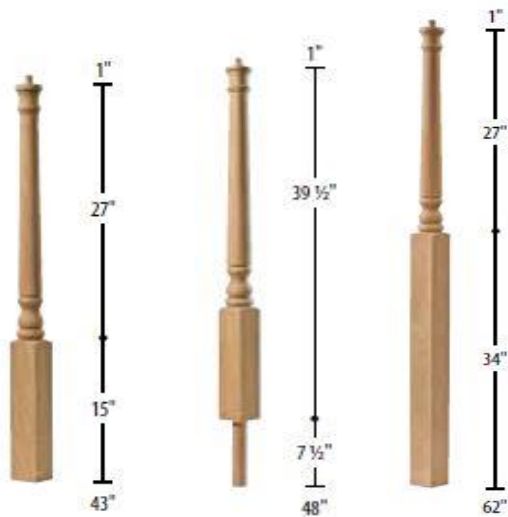

SW-4010 Oak 3" x 43" Starting Newel
 SW-4093 Oak 3" x 48" Volute Newel
 SW-4015 3" x 62" Landing Newel

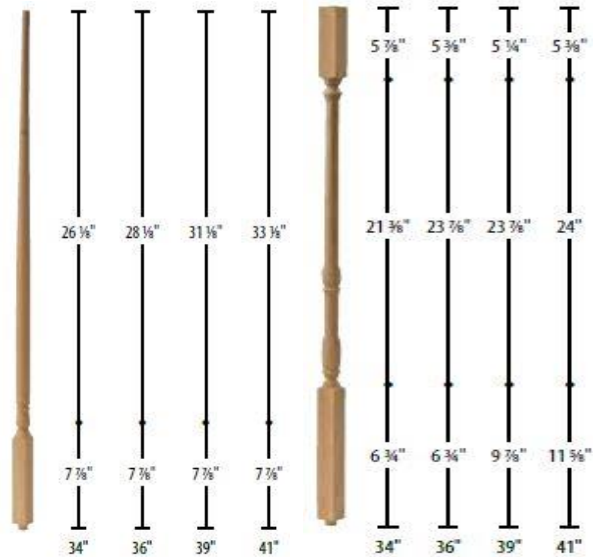

SW-5015 Oak

SW-5067 Oak



RAILS

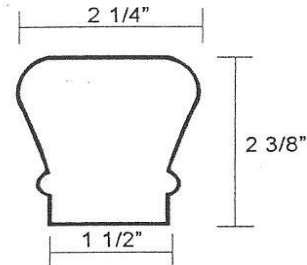

SW-6010 Oak
Available
1-1/4" Plowed

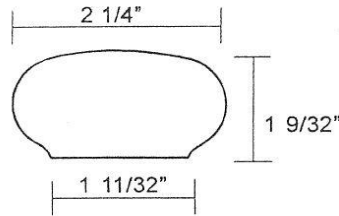

SW-6042 Oak
Wall Rail

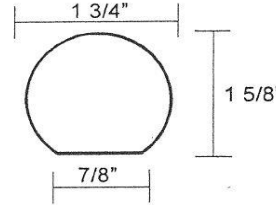

SW-6040 Oak
Wall Rail

SW-6050 Oak Fillet

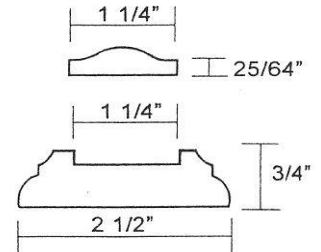

SW-6045 Oak
Shoe Rail

STARTING FITTINGS



Starting Easing

SW-7010



Starting Easing Return End

SW-7015



Over Easing Return End

SW-7016



Opening Cap

SW-7019



Left Hand Volute

SW-7030



Right Hand Volute

SW-7035



5" Left Hand
Turnout

SW-7040



5" Right Hand
Turnout

SW-7045



Red Oak Stair Parts

By Southwest Mouldings

Oak Rail Stock

SW-6010	TRADITIONAL RAIL with Solid TOP (Top ply is solid in 10' & 12' lengths; one (1) FINGERJOINT in 14' & 16' lengths)	10'	ea.	\$89.30
		12'	ea.	\$107.10
		14'	ea.	\$124.90
		16'	ea.	\$142.80
SW-6010-P	PLOWED Traditional RAIL with Solid Top with FILLET (Top ply is solid in 10' & 12' lengths; one (1) FINGERJOINT in 14' & 16' lengths)	10'	ea.	\$112.40
		12'	ea.	\$135.30
		14'	ea.	\$157.40
		16'	ea.	\$179.80
SW-6010-B	Traditional Bending Rail (Random Length Only)		lft.	\$15.30
SW-6010-BM	Bend Rail Mould for Traditional Rail (Mixed Wood)		lft.	\$1.40
SW -6042	Wall Rail 2 1/4" x 19/32" (FINGERJOINT every 4' all lengths)	10'	ea.	\$35.90
		12'	ea.	\$43.20
		14'	ea.	\$50.40
		16'	ea.	\$57.50
SW -6040	Wall Rail 1 3/4" x 1 5/8" (FINGERJOINT every 4' all lengths)	10'	ea.	\$38.90
		12'	ea.	\$46.60
		14'	ea.	\$54.40
		16'	ea.	\$62.20
SW -6045	Plowed Shoe Rail with FILLET (FINGERJOINT every 4' all lengths)	10'	ea.	\$42.20
		12'	ea.	\$50.60
		14'	ea.	\$59.10
		16'	ea.	\$67.50
SW -6050	Traditional Fillet (Random Length Only)		lft.	\$0.90

Oak Rail Starting Fittings (for SW-6010 or SW-6010-P Rail)

SW-7010	Starting Easing with CAP	ea.	\$22.90
SW-7015	Starting Easing	ea.	\$20.80
SW-7016	Over Easing	ea.	\$20.60
SW-7019	Opening Cap	ea.	\$11.70
SW-7030	Left Hand Volute	ea.	\$57.90
SW-7035	Right Hand Volute	ea.	\$57.90
SW-7040	Left Hand Turnout	ea.	\$36.40
SW-7045	Right Hand Turnout	ea.	\$36.40

PRICE SUBJECT TO CHANGE WITHOUT NOTICE



Red Oak Stair Parts
By Southwest Mouldings

Oak Rail Fittings (for SW-6010 or SW-6010-P Rail)

Up Easings, Caps, Quarterturns

SW-7012	Up Easing	ea.	\$14.40
SW-7013	Over Easing	ea.	\$14.20
SW-7020	Tandem Cap	ea.	\$17.40
SW-7021	Quarterturn Cap	ea.	\$20.30
SW-7011	Quarterturn	ea.	\$17.60

Goosneck Fittings

SW-7080	Left Hand (with Cap)	1 Riser	(Discontinued)	ea.	\$35.40
SW-7085	Right Hand (with Cap)	1 Riser	(Discontinued)	ea.	\$35.40
SW-7090	Left Hand	1 Riser	(Discontinued)	ea.	\$42.10
SW-7088	Straight (with tandem Cap)	2 Riser		ea.	\$44.00
SW-7097	Straight (with Cap)	2 Riser		ea.	\$37.30
SW-7060	Left Hand (with Cap)	2 Riser		ea.	\$59.10
SW-7065	Right Hand (with Cap)	2 Riser		ea.	\$59.10
SW-7081	Left Hand (with Cap)	2 Riser		ea.	\$46.40
SW-7086	Right Hand (with Cap)	2 Riser		ea.	\$46.40
SW-7099	Straight	2 Riser		ea.	\$33.10







PRICE SUBJECT TO CHANGE WITHOUT NOTICE



UP EASINGS, CAPS, QUARTERTURNS

- | | | | | |
|---|---|---|--|---|
|  |  |  |  |  |
| 60° Up Easing | Over Easing | Tandem Cap | 90° Quarter Turn Cap | Level Quarter Turn |
| SW-7012 | SW-7013 | SW-7020 | SW-7021 | SW-7011 |

GOOSENECK FITTINGS

- | | | | |
|---|---|--|---|
|  |  |  | |
| 2 Riser With Tandem Cap | 2 Riser With Cap | 2 Riser, No Cap | |
| SW-7088 | SW-7097 | SW-7099 | |
|  |  |  |  |
| Left Hand
2 Riser With Cap | Right Hand
2 Riser With Cap | Left Hand
2 Riser With Cap | Right Hand
2 Riser With Cap |
| SW-7060 | SW7065 | SW-7081 | SW-7086 |



ROSETTES AND HARDWARE



SW-7017
Round Rosette



SW-7037
Oval Rosette



SW-3000 Oak
1" Rail Plug



SW-3001
Rail Bolt



SW-3004
Rail Bolt Wrench



SW-3003
Dowel Screw



SW-3008 & SW-3006
Rail & Dowel Screw Driver



SW-3002
Heavy Duty
Rail Bracket



3004
NEWEL MOUNTING KIT

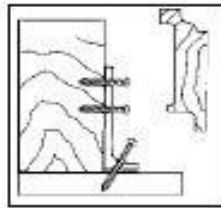

SW-LBR-01 & SW-LBR-03
L-Bracket Newel Fastener
For 3" & 3-1/2" Newel



SW-Stite
Sure Tite Fastener

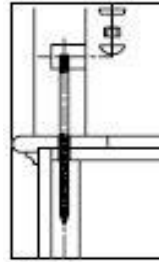

SW-KNFAST
Keylock Fastener

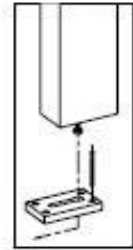

TREADS, RISERS, BRACKETS, STEPS, AND MOULDING



SW-8071 Tread
Cap With Mitered Return



SW-8072 Tread
False End non Mitered



SW-8076
Riser Cap
5-1/2" x 8"



SW-7029
Scroll Bracket



SW-7028
Plain Bracket



SW-8010-2
False Starting Step
Reversible

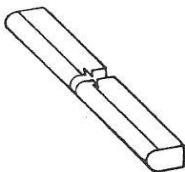

SW-8080
TREAD NOSING

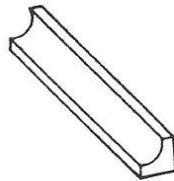

SW-8095
COVE



SW-8010 STARTING STEP
BULL NOSED ONE END



SW-8015 STARTING STEP
BULL NOSED TWO ENDS



Red Oak Stair Parts

By Southwest Mouldings

Rail / Baluster Accessories

SW-3000	1" Oak Rail Plug		ea.	\$0.40
SW-3001	Rail Bolt		ea.	\$0.70
SW-3003	Dowel Screw	(5/16" x 2 1/2")	ea.	\$0.40
SW-3004	Rail Bolt Wrench		ea.	\$17.60
SW-3006	Dowel Screw Driver		ea.	\$19.40
SW-3008	Rail Bolt Driver		ea.	\$20.80
SW-3002HSN	Heavy Duty Rail Bracket	Satin Nickel	ea.	\$6.60
SW-3002HORB	Heavy Duty Rail Bracket	Oil Rubbed Bronze	ea.	\$7.00

Oak Newel Fastener Hardware

3004	Newel Mounting Kit		ea.	\$19.30
SW-STITE	Sure TITE Newel Fastener		ea.	\$12.90
SW-KNFAST	Keylock Newel Fastener		ea.	\$19.80
SW-LBR-01	L-Bracket Newel Fastener	For 3" Newel	ea.	\$23.40
SW-LBR-03	L-Bracket Newel Fastener	For 3 1/2" Newel	ea.	\$23.30
SW-LBROAK	30" Newel Bracket Molding		ea.	\$13.70

Oak Starting Steps

SW-8010	48" Bull Nosed One End	(Reversible)	ea.	\$201.40
	60" Bull Nosed One End	(Reversible)	ea.	\$249.60
SW-8015	42" to 48" Bull Nosed Two Ends	(Adjustable)	ea.	\$277.00
	48" to 54" Bull Nosed Two Ends	(Adjustable)	ea.	\$294.50
SW -8010-C&S	Oak Cove & Shoe Set		set	\$29.80
SW -8015-C&S	Oak Cove & Shoe Set		set	\$59.40

Oak False Tread & Riser Ends

SW-8010-2	False End Starting Step W/Cove & Shoe		ea.	\$84.00
SW-8071L	1/2" x 5 1/2" x 12 5/8" Left Hand Tread End		ea.	\$13.20
SW-8071R	1/2" x 5 1/2" x 12 1/2" Right Hand Tread End		ea.	\$13.20
SW-8072	1/2" x 5 1/2" x 12 5/8" Wall Side Tread End		ea.	\$7.10
SW-8076	1/2" x 5 1/2" x 8" False Riser End		ea.	\$3.40

Oak Stair Brackets

SW-7028	5/16" x 8" x 11 1/2" Plain SOLID OAK		ea.	\$5.30
SW-7029	5/16" x 8" x 11 1/2" Scroll SOLID OAK		ea.	\$5.10

Oak Mouldings

SW-8080	1 1/4" x 1 1/32" Tread Nosing		lft.	\$1.80
SW-8095	1/2" x 3/4" Cove		lft.	\$1.00
S-8422	1/2" x 3/4" Shoe		lft.	\$1.20

Oak Rosettes

SW-7017	4 1/2" Round		ea.	\$5.40
SW-7037	4" x 5 1/2" Oval		ea.	\$5.30

PRICE SUBJECT TO CHANGE WITHOUT NOTICE



Page:H-10
4/6/20

Paint Grade Stair Parts

By Southwest Mouldings

Newels

(For Post to Post for SW-H6010 Rail System)

Newels below are Hemlock Fir

SW-H4004	3 1/4" x 48" Starting Newel		ea.	\$61.70
SW-H4040	3 1/4" x 48" Starting Newel with Turned Center		ea.	\$65.00
SW-H4005	3 1/4" x 60" Landing Newel		ea.	\$73.00
SW-H4046	3 1/4" x 60" Landing Newel with Turned Center		ea.	\$75.40

BOX Newels

SW-P4091	5-1/2" X 55-3/4" Poplar Plain Box Newel		ea.	\$148.80
----------	---	--	-----	----------

Rail Stock

Rails Below are Hemlock Fir

SW-H6010	2 1/4" x 2 3/8"	12'	ea.	\$50.80
		14'	ea.	\$59.20
		16'	ea.	\$67.70
SW-H6040	1 3/4" x 1 5/8"	12'	ea.	\$19.20
		14'	ea.	\$22.40
		16'	ea.	\$25.60

Oval Wall Rosette

SW-H7037	4" x 5-1/2" Oval Rosette Hemlock Fir		ea.	\$3.50
----------	--------------------------------------	--	-----	--------

Primed Stair Parts

Primed Balusters

(for SW-6010 or SW-6010-P Rail)

SW-PR5015	1 1/4" x 31"	Colonial	(Discontinued)	ea.	\$4.60
	1 1/4" x 34"	Same		ea.	\$5.00
	1 1/4" x 36"	"		ea.	\$5.30
	1 1/4" x 39"	"		ea.	\$5.80
	1 1/4" x 41"	"		ea.	\$6.10
SW-PR5067	1 1/4" x 34"	Turned Center		ea.	\$5.00
	1 1/4" x 36"	Same		ea.	\$5.30
	1 1/4" x 39"	"		ea.	\$5.90
	1 1/4" x 41"	"		ea.	\$6.10
SW-PR5060	1 1/4" x 41"	S4S		ea.	\$5.80

Note: (1) Type of wood used in Paint grade stair parts is MILL OPTION.

PRICE SUBJECT TO CHANGE WITHOUT NOTICE



NEWELS

RAILS

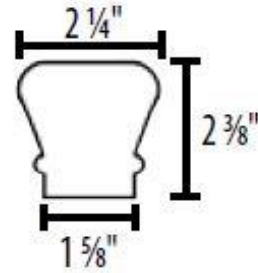
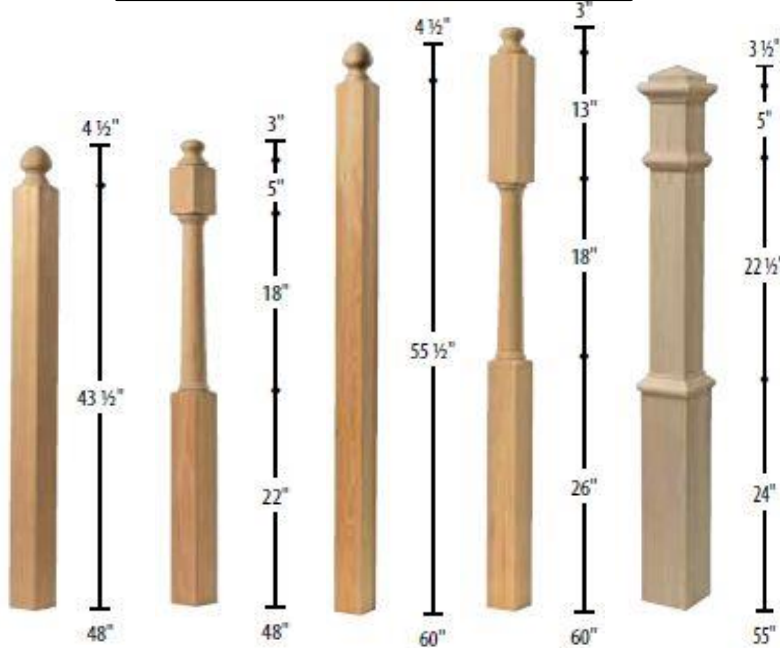

SW-H6010

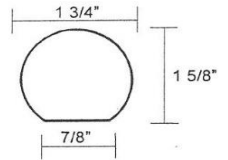

SW-H6040

SW-H4004 HEMLOCK 3-1/4" STARTING NEWEL
 SW-H4040 HEMLOCK 3-1/4" STARTING NEWEL
 SW-H4005 HEMLOCK 3-1/4" LANDING NEWEL
 SW-H4046 HEMLOCK 3-1/4" LANDING NEWEL
 SW-4091 POPLAR BOX NEWEL

BALUSTERS

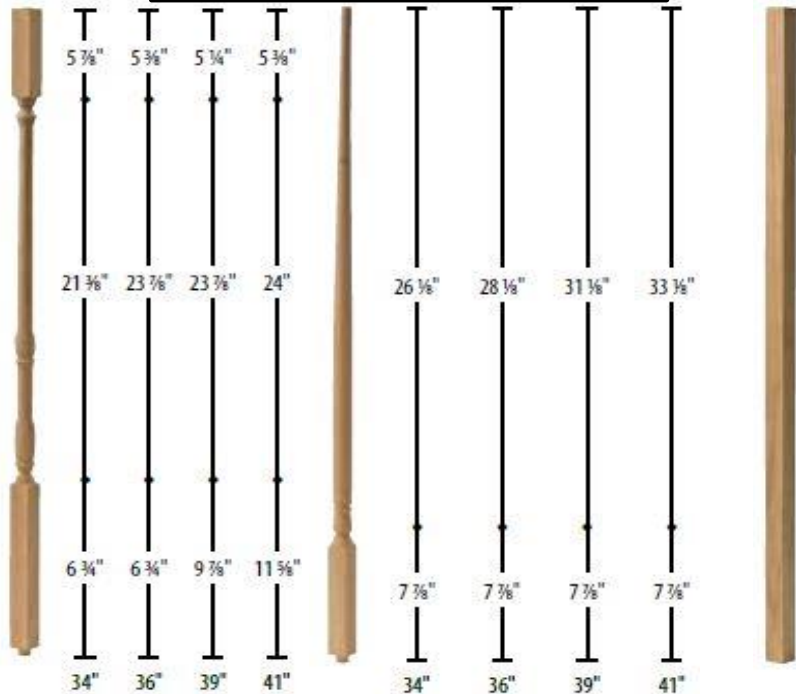

SW-PR5067

SW-PR5015

SW-PR5060

ROSETTES



SW-H7037
OVAL ROSETTE



Iron Stair Parts
By Southwest Mouldings

Iron Balusters

S-M658	1/2" x 44"	Single Twist	Lite Iron Satin Black	ea.	\$5.00
S-M533	1/2" x 44"	Double Twist	Same	ea.	\$5.20
S-M482	1/2" x 44"	Single Basket	Lite Iron Satin Black	ea.	\$8.70
S-M481	1/2" x 44"	Double Basket	"	ea.	\$11.50
S-M701	1/2" x 44"	Plain	"	ea.	\$4.50
S-M452	1/2" x 44"	Scroll	Satin Black	ea.	\$20.10

NOTE : Lite Iron Balusters are Hollow except for the Basket area and are easy to cut.
The structural integrity is equal to a Solid Baluster.

Accessories for Forged Balusters

S-06	Flat Shoe with Set Screw	ea.	\$1.50
SM-798	Adjustable Knuckle with Set Screw	ea.	\$2.70
S-02	Rake Shoe with Set Screw	ea.	\$1.80
S-EPOXY	Adhesive	ea.	\$19.40
S-GUN	Manual Dispenser	ea.	\$140.70
S-NOZZLE	Mixing Nozzle	ea.	\$4.70



IRON BALUSTERS



SM-658
SATIN BLACK
1/2" X 44"
SINGLE TWIST



SM-533
SATIN BLACK
1/2" X 44"
DOUBLE TWIST



SM-482
SATIN BLACK
1/2" X 44"
SINGLE BASKET



SM-481
SATIN BLACK
1/2" X 44"
DOUBLE BASKET



SM-701
SATIN BLACK
1/2" X 44"
PLAIN



SM-452
SATIN BLACK
1/2" X 44"
SCROLL

IRON ACCESSORIES



SM-06
SATIN BLACK
BALUSTER FLAT SHOE



SM-02
SATIN BLACK
BALUSTER RAKE SHOE



SM-798
SATIN BLACK
ADJUSTABLE KNUCKLE
WITH SET SCREW



Red Oak Stair Treads & Risers

By Young Manufacturing

8070 Plain Tread Red Oak

36"	1 1/32" x 11 1/2"	ea.	\$27.20
42"	1 1/32" x 11 1/2"	ea.	\$32.30
48"	1 1/32" x 11 1/2"	ea.	\$37.60
54"	1 1/32" x 11 1/2"	ea.	\$44.20
60"	1 1/32" x 11 1/2"	ea.	\$49.00
72"	1 1/32" x 11 1/2"	ea.	\$58.40

8070MR Single Return Tread Red Oak

42"	1 1/32" x 11 1/2"	ea.	\$38.70
48"	1 1/32" x 11 1/2"	ea.	\$44.00
54"	1 1/32" x 11 1/2"	ea.	\$50.60
60"	1 1/32" x 11 1/2"	ea.	\$55.40
72"	1 1/32" x 11 1/2"	ea.	\$67.80

Retrun treads width is the overall
size including the return

8075 Riser Red Oak

42"	3/4" x 7 1/2"	ea.	\$17.60
48"	3/4" x 7 1/2"	ea.	\$20.50
60"	3/4" x 7 1/2"	ea.	\$26.50

8090 Landing Tread Red Oak

3 1/2" Lft. \$4.10

8090-5 Landing Tread Red Oak

5 1/4" Lft. \$5.90

8080-13 Tread Return Nosing 1-1/16" X 1-1/4" X 13"

ea. \$2.00

RETROTREADS PLAIN

42"	5/8" x 11 1/2"	ea.	\$34.20
48"	5/8" x 11 1/2"	ea.	\$39.90

8080 Reversible Return Retronosing 1" x 1-7/8" x 14-3/4"

ea. \$4.70

MISCELLANEOUS OAK TREAD MACHINING

Contact Barnett for pricing on double return treads

To CUT DOWN a Tread or Riser Length	ADD	\$10.00
-------------------------------------	-----	---------

PRICE SUBJECT TO CHANGE WITHOUT NOTICE



**EDGE GLUED SOUTHERN PINE
TREADS AND RISERS
Manufactured By Barnett Millworks Inc.**

Stair Treads Plain

			<i>C & BETTER</i>	<i>CARPET</i>
42"	1" x 11 1/2"	ea.	\$24.00	\$13.00
48"	1" x 11 1/2"	ea.	\$28.00	\$14.00
60"	1" x 11 1/2"	ea.	\$40.00	\$18.00

Stair Treads Plain Single Return

42"	1" x 11 1/2"	ea.	\$47.00
48"	1" x 11 1/2"	ea.	\$51.00
60"	1" x 11 1/2"	ea.	\$62.00

Stair Risers

			<i>C & BETTER</i>	<i>CARPET</i>
42"	3/4" x 7 1/2"	ea.	\$12.00	\$8.00
48"	3/4" x 7 1/2"	ea.	\$14.00	\$9.00
60"	3/4" x 7 1/2"	ea.	\$17.00	\$11.00

Pine Landing Tread 3/4" x 1 1/32" x 5 1/2" (Plowed for 3/4" Flooring) lft. \$6.00

Pine Tread Nosing 1 1/4" x 1 1/32" Tread Nosing lft. \$2.00
Pine Tread Nosing Applied to One End of Tread ea. \$22.00

Pine Hand Rail

6010	TRADITIONAL RAIL SOLID	lft.	\$9.00
231	WALL HAND RAIL SOLID	lft.	\$2.00



TREADS

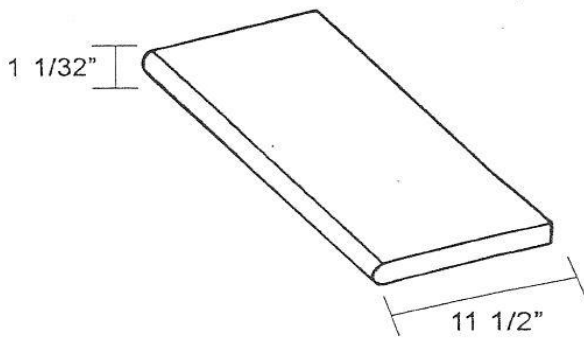

8070 PLAIN TREAD

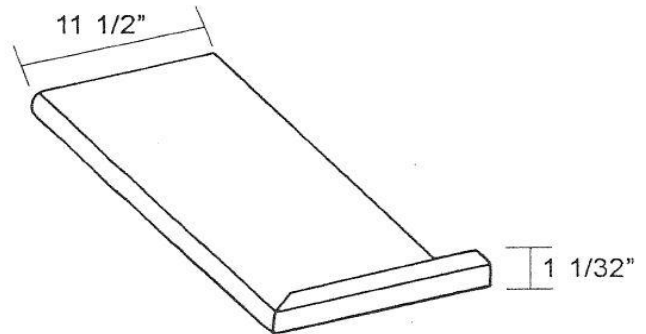

8070MR SINGLE MITERED
RETURN TREAD

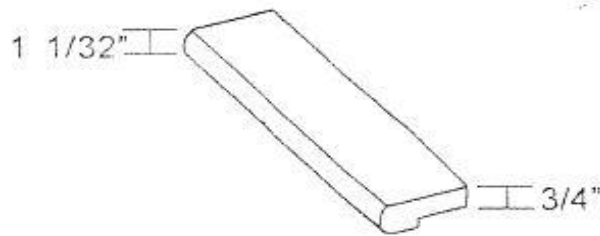

LANDING TREAD

