



SECTION - H - INDEX

| | PAGE NUMBER |
|---|-------------|
| RED OAK STAIR PARTS | |
| NEWELS | H-2 |
| BALUSTERS | H-2 |
| NEWEL AND BALUSTER DRAWINGS | H-3 |
| RAIL AND FITTING DRAWINGS | H-4 |
| COLONIAL RAIL / PLOWED RAIL | H-5 |
| HANDRAIL AND WALLRAIL | H-5 |
| PLOWED SHOE RAIL | H-5 |
| RAIL FITTINGS | H-5 |
| RAIL FITTINGS | H-5 |
| HARDWARE, STEPS, AND ACCESSORIES DRAWINGS | H-6 |
| BALUSTER AND NEWEL HARDWARE | H-7 |
| ROSETTES | H-7 |
| STARTING STEPS | H-7 |
| FALSE TREADS & RISERS | H-7 |
| STAIR BRACKETS | H-7 |
| MOULDING | H-7 |
| WHITE OAK STAIR PARTS | |
| NEWELS | H-8 |
| RAILS | H-8 |
| ROSETTES | H-8 |
| IRON STAIR PARTS | |
| BALUSTERS | H-9 |
| BALUSTER ACCESSORIES | H-9 |
| IRON STAIR PART DRAWINGS | H-9 |
| PAINT GRADE STAIR PARTS | |
| NEWELS | H-10 |
| RAILS | H-10 |
| ROSETTES | H-10 |
| BALUSTERS | H-10 |
| PAINT GRADE STAIR PARTS DRAWINGS | H-11 |
| RED OAK TREADS AND RISERS | H-12 |
| RED OAK RETRO TREADS WHITE | H-12 |
| OAK TREADS AND RISERS PINE | H-13 |
| TREADS AND RISERS | H-14 |
| TREAD DRAWINGS | H-15 |
| Discontinued Stair Parts | H-16 & 17 |



Red Oak Stair Parts

| <u>Oak Newels</u> | <u>(for post to post 6010 or 6010-P rail systems)</u> | | |
|-----------------------|--|-----|----------|
| 4040 | 3" x 48" Starting Newel | ea. | \$58.50 |
| 4042 | 3" x 57-5/8" Starting Newel | ea. | \$80.20 |
| 4045 | 3" x 57-5/8" Landing Newel | ea. | \$80.20 |
| 4055 | 3" x 72" Intermediate Newel | ea. | \$96.30 |
| | | | |
| <u>Oak Newels</u> | <u>(for over the post 6010 or 6010-P rail systems)</u> | | |
| 4010 | 3" x 43" Starting Newel | ea. | \$64.70 |
| 4015 | 3" x 62" Landing Newel | ea. | \$78.40 |
| | | | |
| <u>Oak Box Newels</u> | | | |
| 4075 | 3 1/2" x 63 3/4" Landing Newel | ea. | \$120.70 |
| 4075SL | 4-1/2" x 22-1/8" Sleeve for 4075 Newel | ea. | \$34.90 |
| 4091 | 6-1/4" x 55" Plain Newel | ea. | \$199.60 |
| | | | |
| <u>Oak Balusters</u> | <u>(for 6010 or 6010-P rail systems)</u> | | |
| 5015 | 1 1/4" x 36" " | ea. | \$11.50 |
| | 1 1/4" x 39" " | ea. | \$12.00 |
| | 1 1/4" x 42" " | ea. | \$12.40 |

PRICE SUBJECT TO CHANGE WITHOUT NOTICE

POST TO POST NEWELS



4040 Oak 4042 Oak 4045 Oak 4055 Oak

BOX NEWELS



4075SL 4075 4091

OVER THE POST NEWEL



4010 Oak 4015 Oak

BALUSTERS

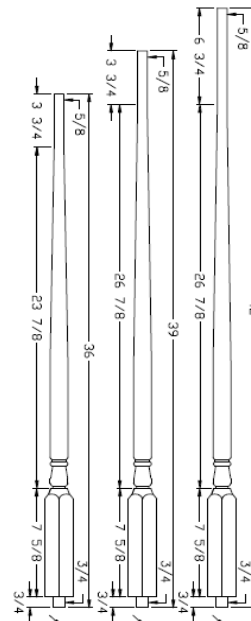

5015 Oak



RAILS

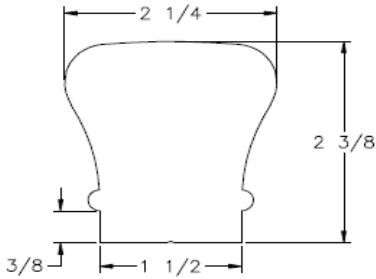

6010 Oak
Available
1-1/4" Plowed

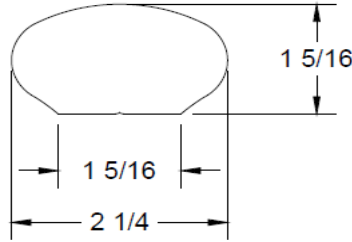

6042 Oak
Wall Rail

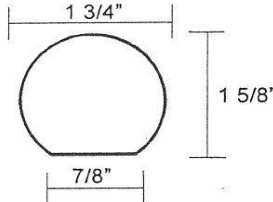

6040 Oak
Wall Rail

SW-6050 Oak Fillet

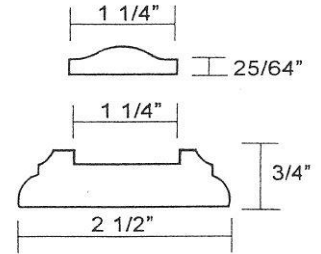

6045 Oak
Shoe Rail

STARTING FITTINGS



Starting Easing
7010



Opening Cap
7019



Left & Right Volute
7030 & 7035



Left & Right Turnout
7040 & 7045

EASINGS, QUARTERTURNS, & GOOSENECKS



Up Easing
7012



Over Easing
7013



90deg Qtr Turn Cap
7021



Level Qtr Turn
7011



2 Riser, No Cap
7099



Red Oak Stair Parts

Oak Rail Stock

| | | | | |
|--------|--|-----|------|----------|
| 6010 | Traditional Rail with Solid Top | 10' | ea. | \$88.80 |
| | (Top ply is solid in 10' & 12' lengths; | 12' | ea. | \$106.50 |
| | one (1) Fingerjoint in 16' lengths) | 16' | ea. | \$142.00 |
| 6010-P | Plowed Traditional Rail Solid Top W/Fillet | 10' | ea. | \$110.10 |
| | (Top ply is solid in 10' & 12' lengths; | 12' | ea. | \$132.10 |
| | one (1) Fingerjoint in 16' lengths) | 16' | ea. | \$176.10 |
| 6042 | Wall Rail 2 1/4" x 19/32" | 12' | ea. | \$51.40 |
| | (Fingerjoint every 4' all lengths) | 16' | ea. | \$77.20 |
| 6040 | Wall Rail 1 3/4" x 1 5/8" | 12' | ea. | \$51.40 |
| | (Fingerjoint every 4' all lengths) | 16' | ea. | \$68.50 |
| 6045 | Plowed Shoe Rail W/Fillet | 12' | ea. | \$47.90 |
| | (Fingerjoint every 4' all lengths) | 16' | ea. | \$63.90 |
| 6050 | Traditional Fillet (Random Length Only) | | lft. | \$1.00 |

Oak Rail Starting Fittings (for 6010 or 6010-P Rail)

| | | | | |
|------|--------------------------|--|-----|---------|
| 7010 | Starting Easing with CAP | | ea. | \$24.50 |
| 7019 | Opening Cap | | ea. | \$23.60 |
| 7030 | Left Hand Volute | | ea. | \$60.80 |
| 7035 | Right Hand Volute | | ea. | \$60.80 |
| 7040 | Left Hand Turnout | | ea. | \$38.20 |
| 7045 | Right Hand Turnout | | ea. | \$38.20 |

Up Easings, Caps, Quarterturns

| | | | | |
|------|-----------------|--|-----|---------|
| 7012 | Up Easing | | ea. | \$14.50 |
| 7013 | Over Easing | | ea. | \$15.30 |
| 7021 | Quarterturn Cap | | ea. | \$20.60 |
| 7011 | Quarterturn | | ea. | \$16.60 |

Goosneck Fittings

| | | | | |
|------|----------|---------|-----|---------|
| 7099 | Straight | 2 Riser | ea. | \$34.30 |
|------|----------|---------|-----|---------|



ROSETTES AND HARDWARE



7026
Round Rosette



7037
Oval Rosette



3001
Rail Bolt & Plug



3044
Rail Bolt Wrench



3076
Dowel Screw



3033 & 3032
Rail & Dowel Screw Driver



3127
Heavy Duty
Rail Bracket



3004
NEWEL MOUNTING KIT

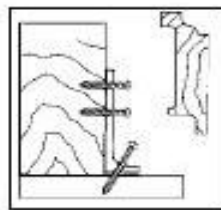

3009 & 3019
L-Bracket Newel Fastener
For 3" & 3-1/2" Newel

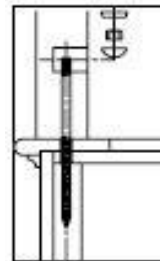

3008-10
Sure Tite Fastener

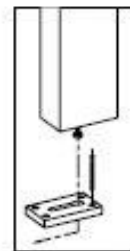

3005
Keylock Fastener

TREADS, RISERS, BRACKETS, STEPS, AND MOULDING



8071 Tread
Cap With Mitered Return



8072 Tread
False End non Mitered



8076
Riser Cap
5-1/2" x 8"



7029
Scroll Bracket



7028
Plain Bracket



8010-2
False Starting Step
Reversible

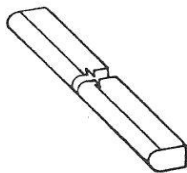

8080
TREAD NOSING

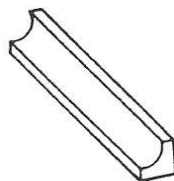

8095
COVE



8422
Shoe



8010 STARTING STEP
BULL NOSED ONE END



Red Oak Stair Parts

Rail / Baluster Accessories

| | | | | |
|---------|-------------------------|-------------------|-----|---------|
| 3001 | Rail Bolt W/1" Oak Plug | | ea. | \$0.70 |
| 3076 | Dowel Screw | (5/16" x 2 1/2") | ea. | \$0.40 |
| 3044 | Rail Bolt Wrench | | ea. | \$7.40 |
| 3033 | Dowel Screw Driver | | ea. | \$8.20 |
| 3032 | Rail Bolt Driver | | ea. | \$31.20 |
| 3127-SN | Heavy Duty Rail Bracket | Satin Nickel | ea. | \$5.30 |
| 3127-BZ | Heavy Duty Rail Bracket | Oil Rubbed Bronze | ea. | \$5.30 |

Oak Newel Fastener Hardware

| | | | | |
|---------|--------------------------|------------------|-----|---------|
| 3004 | Newel Mounting Kit | | ea. | \$5.60 |
| 3008-10 | Sure TITE Newel Fastener | | ea. | \$7.50 |
| 3005 | Keylock Newel Fastener | | ea. | \$15.20 |
| 3009 | L-Bracket Newel Fastener | For 3" Newel | ea. | \$14.70 |
| 3019 | L-Bracket Newel Fastener | For 3 1/2" Newel | ea. | \$16.60 |

Oak Starting Steps

| | | | | |
|----------|------------------------|----------------|-----|----------|
| 8010-48 | 48" Bull Nosed One End | (Reversible) | ea. | \$268.40 |
| 8010-60 | 60" Bull Nosed One End | (Reversible) | ea. | \$313.30 |
| 8010-C&S | Oak Cove & Shoe Set | | set | \$16.30 |
| 8015-C&S | Oak Cove & Shoe Set | | set | \$29.90 |

Oak False Tread & Riser Ends

| | | | | |
|-------|--|--|-----|---------|
| 8071L | 1/2" x 5 1/2" x 12 5/8" Left Hand Tread End | | ea. | \$17.90 |
| 8071R | 1/2" x 5 1/2" x 12 1/2" Right Hand Tread End | | ea. | \$17.90 |
| 8072 | 1/2" x 5 1/2" x 12 5/8" Wall Side Tread End | | ea. | \$10.60 |
| 8076 | 1/2" x 5 1/2" x 8" False Riser End | | ea. | \$5.70 |

Oak Stair Brackets

| | | | | |
|------|---------------------------------------|--|-----|---------|
| 7028 | 5/16" x 8" x 11 1/2" Plain SOLID OAK | | ea. | \$12.00 |
| 7029 | 5/16" x 8" x 11 1/2" Scroll SOLID OAK | | ea. | \$12.00 |

Oak Mouldings

| | | | | |
|------|-------------------------------|--|------|--------|
| 8080 | 1 1/4" x 1 1/32" Tread Nosing | | lft. | \$3.40 |
| 8095 | 1/2" x 3/4" Cove | | lft. | \$1.00 |
| 8422 | 1/2" x 3/4" Shoe | | lft. | \$1.00 |

Oak Rosettes

| | | | | |
|------|------------------|--|-----|--------|
| 7026 | 4 1/2" Round | | ea. | \$5.10 |
| 7037 | 4" x 5 1/2" Oval | | ea. | \$5.20 |

PRICE SUBJECT TO CHANGE WITHOUT NOTICE



White Oak Stair Parts

White oak Handrail & Wall Rail

| | | | | |
|-----------|--|-----|-----|----------|
| 6010-WO | Traditional Rail with Solid Cap (Top ply is solid in 12' lengths; one Fingerjoint in 16' lengths) | 12' | ea. | \$124.10 |
| | | 16' | ea. | \$165.50 |
| 6010-P-WO | Plowed Traditional Rail with Solid Cap W/Fillet (Top ply is solid in 12' lengths; one Fingerjoint in 16' lengths) | 12' | ea. | \$205.10 |
| | | 16' | ea. | \$273.50 |
| 6040-WO | Wall Rail 1 3/4" x 1 5/8" (Top ply is solid in 12' lengths; one Fingerjoint in 16' lengths) | 12' | ea. | \$116.40 |
| | | 16' | ea. | \$152.10 |

White oak Rosettes

| | | | |
|---------|--------------------------|-----|---------|
| 7037-WO | 4" x 5 1/2" Oval Rosette | ea. | \$15.60 |
|---------|--------------------------|-----|---------|

White oak Box Newels

| | | | |
|---------|--------------------------|-----|----------|
| 4091-WO | 6-1/4" x 55" Plain Newel | ea. | \$268.30 |
|---------|--------------------------|-----|----------|

NEWELS



4091
BOX NEWEL

ROSETTES



7037
OVAL ROSETTE

RAILS

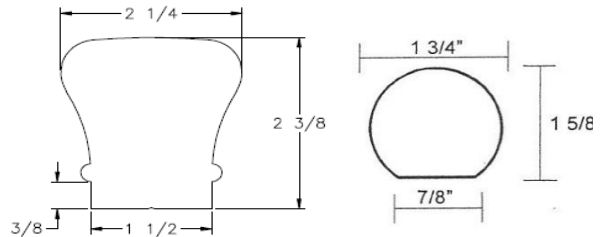

6010

6040

PRICE SUBJECT TO CHANGE WITHOUT NOTICE

Iron Stair Parts

Iron Balusters

| | | | | | |
|--------------------|------------|---------------|-----------------------|-----|---------|
| LIH-HOL1TW44-LSB | 1/2" x 44" | Single Twist | Lite Iron Satin Black | ea. | \$5.00 |
| LIH-HOL2TW44-LSB | 1/2" x 44" | Double Twist | Same | ea. | \$4.90 |
| LIH-HOL1BASK44-LSB | 1/2" x 44" | Single Basket | Lite Iron Satin Black | ea. | \$8.20 |
| LIH-HOL2BASK44-LSB | 1/2" x 44" | Double Basket | " | ea. | \$9.90 |
| LIH-HOLPLA44-LSB | 1/2" x 44" | Plain | " | ea. | \$3.80 |
| LIH-HOL30144-MB | 1/2" x 44" | Scroll | Satin Black | ea. | \$19.40 |

NOTE : Lite Iron Balusters are Hollow except for the Basket area and are easy to cut. The structural integrity is equal to a Solid Baluster.

Accessories for Forged Balusters

| | | | |
|----------------|-----------------------------------|-----|--------|
| LI-ALM06-LSB | Flat Shoe with Set Screw | ea. | \$1.20 |
| LI-ALAK01-LSB | Adjustable Knuckle with Set Screw | ea. | \$1.90 |
| LI-ALPSH02-LSB | Rake Shoe with Set Screw | ea. | \$1.60 |

LI-3704 Epoxy Kit : Includes built in dispensing system, 5oz Adhesive cartridge and nozzle. Open work time is 6 minute. Fills approximately 35 holes depending the hole size. ea. \$29.60

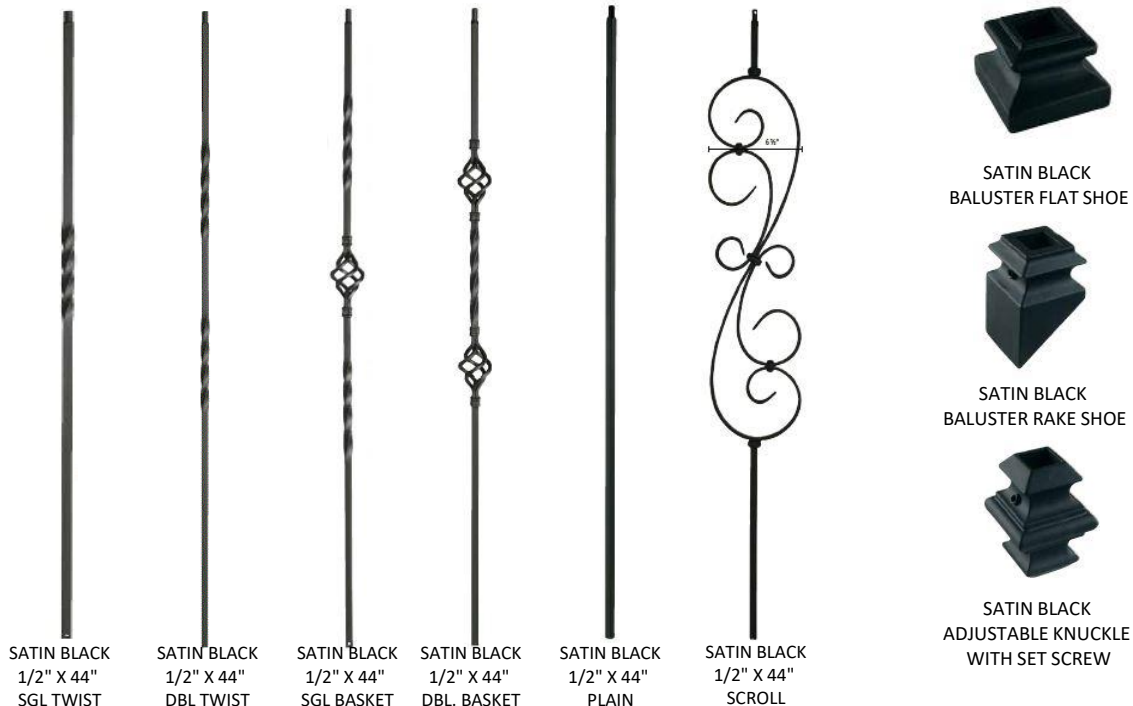

PRICE SUBJECT TO CHANGE WITHOUT NOTICE



Paint Grade Stair Parts

Stair Parts Below are Paint Grade Hemlock or Poplar depending on what is available

Newels (For Post to Post for 6010 Rail System)

| | | | | |
|--------|--|--|-----|---------|
| 4004-P | 3 1/4" x 48" Starting Newel | | ea. | \$62.30 |
| 4040-P | 3 1/4" x 48" Starting Newel with Turned Center | | ea. | \$50.50 |
| 4005-P | 3 1/4" x 60" Landing Newel | | ea. | \$67.70 |
| 4046-P | 3 1/4" x 60" Landing Newel with Turned Center | | ea. | \$68.40 |

BOX Newels

| | | | | |
|--------|---|--|-----|----------|
| 4091-P | 6-1/4" X 55-3/4" Poplar Plain Box Newel | | ea. | \$178.80 |
|--------|---|--|-----|----------|

Rail Stock

| | | | | |
|--------|-----------------|-----|-----|----------|
| 6010-P | 2 1/4" x 2 3/8" | 12' | ea. | \$68.30 |
| | | 16' | ea. | \$111.30 |
| 6040-P | 1 3/4" x 1 5/8" | 12' | ea. | \$31.70 |
| | | 16' | ea. | \$60.10 |

Oval Wall Rosette

| | | | | |
|--------|--------------------------|--|-----|---------|
| 7037-P | 4" x 5-1/2" Oval Rosette | | ea. | \$13.20 |
|--------|--------------------------|--|-----|---------|

Primed Stair Parts

Primed Balusters (for SW-6010 or SW-6010-P Rail)

| | | | | |
|--------|--------------|---------------|-----|--------|
| PR5015 | 1 1/4" x 34" | Same | ea. | \$4.80 |
| | 1 1/4" x 36" | " | ea. | \$5.10 |
| | 1 1/4" x 39" | " | ea. | \$5.50 |
| | 1 1/4" x 42" | " | ea. | \$6.00 |
| PR5067 | 1 1/4" x 34" | Turned Center | ea. | \$4.70 |
| | 1 1/4" x 36" | Same | ea. | \$5.30 |
| | 1 1/4" x 39" | " | ea. | \$5.70 |
| | 1 1/4" x 42" | " | ea. | \$6.10 |
| PR5060 | 1 1/4" x 42" | S4S | ea. | \$5.70 |

**Note: (1) Type of wood used in Paint grade stair parts is MILL OPTION.
PRICE SUBJECT TO CHANGE WITHOUT NOTICE**

NEWELS

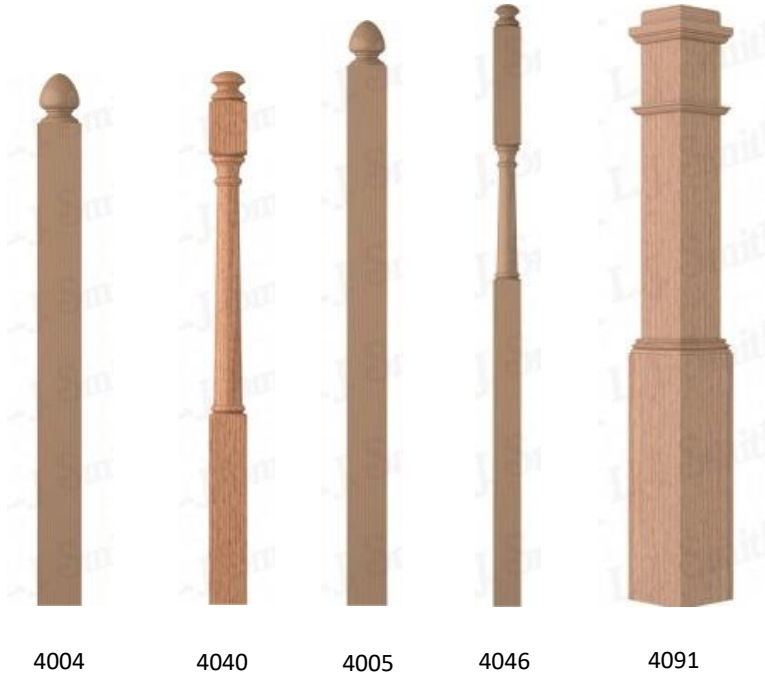

RAILS

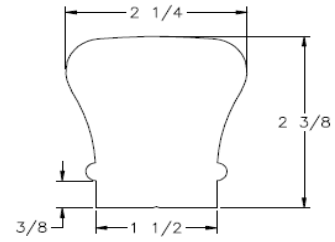

6010

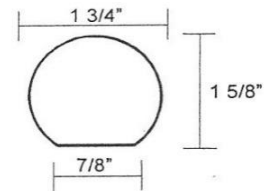

6040

BALUSTERS

ROSETTES



7037
OVAL ROSETTE

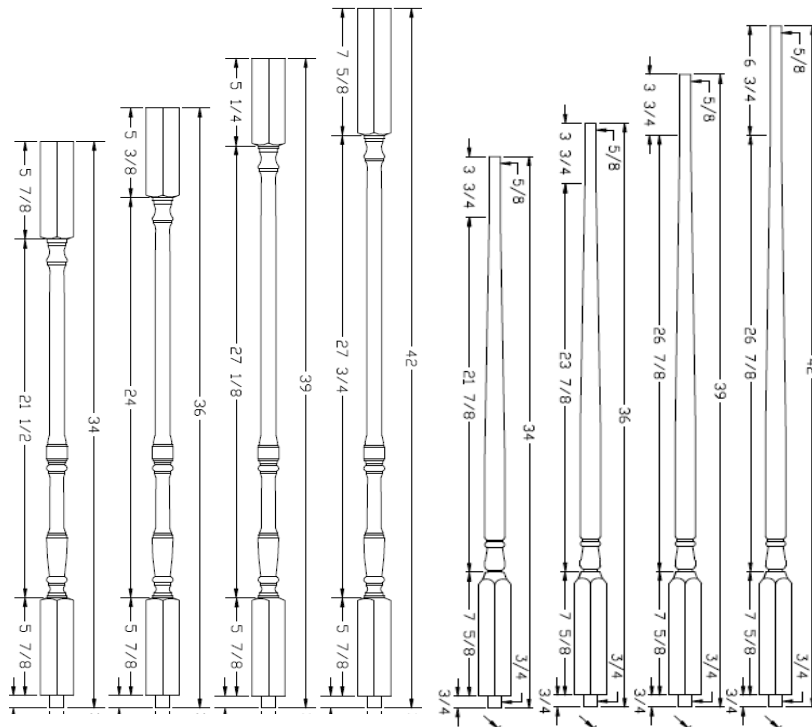

PR5067

PR5015

PR5060





Red Oak Stair Treads & Risers
By Young Manufacturing

8070 Plain Tread Red Oak

| | | | | |
|-----|--|-------------------|-----|---------|
| 36" | | 1 1/32" x 11 1/2" | ea. | \$25.60 |
| 42" | | 1 1/32" x 11 1/2" | ea. | \$30.40 |
| 48" | | 1 1/32" x 11 1/2" | ea. | \$35.40 |
| 54" | | 1 1/32" x 11 1/2" | ea. | \$41.70 |
| 60" | | 1 1/32" x 11 1/2" | ea. | \$46.10 |
| 72" | | 1 1/32" x 11 1/2" | ea. | \$55.00 |

8070MR Single Return Tread Red Oak

| | | | | |
|-----|------------------------------------|-------------------|-----|---------|
| 42" | | 1 1/32" x 11 1/2" | ea. | \$37.40 |
| 48" | | 1 1/32" x 11 1/2" | ea. | \$42.30 |
| 54" | Retrun treads width is the overall | 1 1/32" x 11 1/2" | ea. | \$48.70 |
| 60" | size including the return | 1 1/32" x 11 1/2" | ea. | \$53.10 |
| 72" | | 1 1/32" x 11 1/2" | ea. | \$62.00 |

8075 Riser Red Oak

| | | | | |
|-----|--|---------------|-----|---------|
| 42" | | 3/4" x 7 1/2" | ea. | \$16.70 |
| 48" | | 3/4" x 7 1/2" | ea. | \$19.40 |
| 60" | | 3/4" x 7 1/2" | ea. | \$25.10 |

8090 Landing Tread Red Oak

3 1/2" Lft. \$3.50

8090-5 Landing Tread Red Oak

5 1/4" Lft. \$5.30

8080-13 Tread Return Nosing 1-1/16" X 1-1/4" X 13"

ea. \$1.70

RETROTREADS PLAIN

| | | | | |
|-----|--|----------------|-----|---------|
| 42" | | 5/8" x 11 1/2" | ea. | \$36.30 |
| 48" | | 5/8" x 11 1/2" | ea. | \$42.30 |

8080 Reversible Return Retronosing 1" x 1-7/8" x 14-3/4"

ea. \$5.70

MISCELLANEOUS OAK TREAD MACHINING

Contact Barnett for pricing on double return treads

To CUT DOWN a Tread or Riser Length ADD \$10.00

PRICE SUBJECT TO CHANGE WITHOUT NOTICE



White Oak Stair Treads & Risers
By Young Manufacturing

8070 Plain Tread White Oak

| | | | |
|-----|-------------------|-----|---------|
| 42" | 1 1/32" x 11 1/2" | ea. | \$44.20 |
| 48" | 1 1/32" x 11 1/2" | ea. | \$50.60 |
| 54" | 1 1/32" x 11 1/2" | ea. | \$59.60 |
| 60" | 1 1/32" x 11 1/2" | ea. | \$66.00 |
| 72" | 1 1/32" x 11 1/2" | ea. | \$78.80 |

8070MR Single Return Tread White Oak

| | | | |
|-----|---|-----|---------|
| 42" | 1 1/32" x 11 1/2" | ea. | \$51.20 |
| 48" | 1 1/32" x 11 1/2" | ea. | \$57.70 |
| 54" | Retrun treads width is the overall size including the return | ea. | \$66.70 |
| 60" | 1 1/32" x 11 1/2" | ea. | \$73.10 |
| 72" | 1 1/32" x 11 1/2" | ea. | \$85.90 |

8075 Riser White Oak

| | | | |
|-----|---------------|-----|---------|
| 42" | 3/4" x 7 1/2" | ea. | \$24.00 |
| 48" | 3/4" x 7 1/2" | ea. | \$27.40 |
| 60" | 3/4" x 7 1/2" | ea. | \$35.60 |

8090-5 Landing Tread White Oak

5 1/4" Lft. \$7.80

8080-13 Tread Return Nosing 1-1/16" X 1-1/4" X 13"

ea. \$2.00



**EDGE GLUED SOUTHERN PINE
TREADS AND RISERS
Manufactured By Barnett Millworks Inc.**

Stair Treads Plain

| | | | <i>C & BETTER</i> | <i>CARPET</i> |
|-----|--------------|-----|-----------------------|---------------|
| 42" | 1" x 11 1/2" | ea. | \$25.00 | \$13.00 |
| 48" | 1" x 11 1/2" | ea. | \$28.00 | \$14.00 |
| 60" | 1" x 11 1/2" | ea. | \$40.00 | \$18.00 |

Stair Treads Plain Single Return

| | | | |
|-----|--------------|-----|---------|
| 42" | 1" x 11 1/2" | ea. | \$63.00 |
| 48" | 1" x 11 1/2" | ea. | \$67.00 |
| 60" | 1" x 11 1/2" | ea. | \$79.00 |

Stair Risers

| | | | <i>C & BETTER</i> | <i>CARPET</i> |
|-----|---------------|-----|-----------------------|---------------|
| 42" | 3/4" x 7 1/2" | ea. | \$12.00 | \$8.00 |
| 48" | 3/4" x 7 1/2" | ea. | \$14.00 | \$9.00 |
| 60" | 3/4" x 7 1/2" | ea. | \$17.00 | \$11.00 |

Pine Landing Tread 3/4" x 1 1/32" x 5 1/2" (Plowed for 3/4" Flooring) lft. \$6.00

Pine Tread Nosing 1 1/4" x 1 1/32" Tread Nosing lft. \$2.00
Pine Tread Nosing Applied to One End of Tread ea. \$26.00

Pine Hand Rail

| | | | |
|------|------------------------|------|--------|
| 6010 | TRADITIONAL RAIL SOLID | lft. | \$9.00 |
| 231 | WALL HAND RAIL SOLID | lft. | \$2.00 |

TREADS

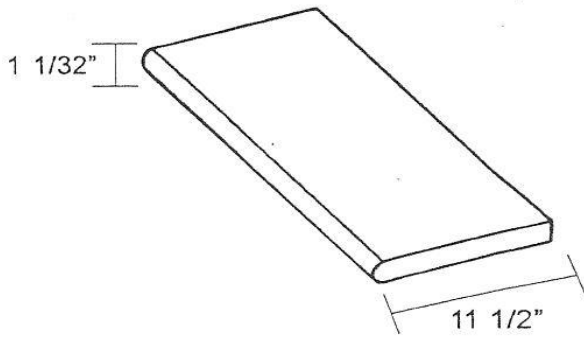

8070 PLAIN TREAD

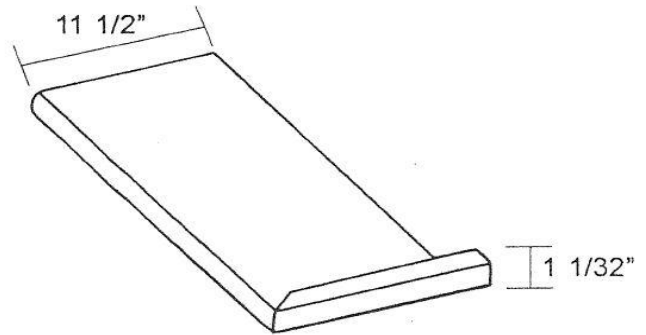

8070MR SINGLE MITERED
RETURN TREAD

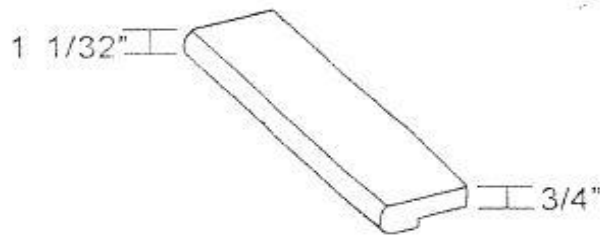

LANDING TREAD

Discontinued Subject to Current Inventory

Oak Newels

| | | | |
|-------------|-------------------------------|-----|----------|
| SW-4093 | 3" X 48" Volute/Turnout Newel | ea. | \$70.70 |
| SW-4017 | 3" x 72" Landing Newel | ea. | \$90.00 |
| SW-4091-F | 5 1/2" x 55" Fluted Newel | ea. | \$189.10 |
| SW-4091-XLF | 6 1/4" x 55" Fluted Newel | ea. | \$219.00 |
| SW-4091 | 5-1/2" x 55" Box Newel | ea. | \$168.80 |

Oak Balusters (for SW-6010 or SW-6010-P rail systems)

| | | | |
|---------|----------------------------|-----|---------|
| SW-5015 | 1 1/4" x 31" Colonial | ea. | \$8.50 |
| | 1 1/4" x 34" Same | ea. | \$11.50 |
| SW-5067 | 1 1/4" x 31" Turned Center | ea. | \$9.20 |
| | 1 1/4" x 34" Same | ea. | \$9.60 |
| | 1 1/4" x 36" " | ea. | \$10.20 |
| | 1 1/4" x 39" " | ea. | \$10.00 |
| | 1 1/4" x 41" " | ea. | \$10.90 |

Oak Rail Stock

| | | | | |
|------------------------------------|---|-----|-----|----------|
| SW-6010 | TRADITIONAL RAIL with Solid TOP | 14' | ea. | \$123.80 |
| SW-6010-P | PLOWED Traditional RAIL with Solid Top with FILLET | 14' | ea. | \$156.00 |
| SW-6010-B | Traditional Bending Rail (Random Length Only) | | lf. | \$15.10 |
| SW-6010-BM | Bend Rail Mould for Traditional Rail (Mixed Wood) | | lf. | \$1.40 |
| SW -6042 | Wall Rail 2 1/4" x 19/32" | 10' | ea. | \$42.80 |
| | | 14' | ea. | \$50.00 |
| (FINGERJOINT every 4' all lengths) | | | | |
| SW -6040 | Wall Rail 1 3/4" x 1 5/8" | 10' | ea. | \$38.50 |
| | | 14' | ea. | \$53.90 |
| (FINGERJOINT every 4' all lengths) | | | | |
| SW -6045 | Plowed Shoe Rail with FILLET | 10' | ea. | \$41.80 |
| | | 14' | ea. | \$58.60 |
| (FINGERJOINT every 4' all lengths) | | | | |

Discontinued Subject to Current Inventory

Page:H-17
9/21/20

Oak Rail Fittings

(for 6010 or 6010-P Rail)

| | | | | |
|-----------|---|---------|-----|----------|
| SW-7015 | Starting Easing | | ea. | \$20.60 |
| SW-7016 | Over Easing | | ea. | \$20.40 |
| SW-7020 | Tandem Cap | | ea. | \$17.20 |
| SW-7080 | Left Hand (with Cap) | 1 Riser | ea. | \$35.00 |
| SW-7085 | Right Hand (with Cap) | 1 Riser | ea. | \$35.00 |
| SW-7090 | Left Hand | 1 Riser | ea. | \$41.70 |
| SW-7088 | Straight (with tandem cap) | 2 Riser | ea. | \$44.00 |
| SW-7097 | Straight (with cap) | 2 Riser | ea. | \$37.30 |
| SW-7060 | Left Hand (with cap) | 2 Riser | ea. | \$59.10 |
| SW-7065 | Right Hand (with cap) | 2 Riser | ea. | \$59.10 |
| SW-7081 | Left Hand (with cap) | 2 Riser | ea. | \$46.40 |
| SW-7086 | Right Hand (with cap) | 2 Riser | ea. | \$46.40 |
| SW-LBROAK | 30" Newel Bracket Molding | | ea. | \$13.70 |
| SW-8015 | 42" to 48" Bull Nosed Two Ends (Adjustable) | | ea. | \$277.00 |
| | 48" to 54" Bull Nosed Two Ends (Adjustable) | | ea. | \$294.50 |

Oak False Tread & Riser Ends

| | | | | |
|-----------|---------------------------------------|--|-----|---------|
| SW-8010-2 | False End Starting Step W/Cove & Shoe | | ea. | \$83.30 |
|-----------|---------------------------------------|--|-----|---------|

Rail Stock

Rails Below are Hemlock Fir

| | | | | |
|----------|-----------------|-----|-----|---------|
| SW-H6010 | 2 1/4" x 2 3/8" | 14' | ea. | \$58.70 |
| SW-H6040 | 1 3/4" x 1 5/8" | 14' | ea. | \$22.20 |

Primed Balusters

(for SW-6010 or SW-6010-P Rail)

| | | | | |
|-----------|-----------------------|--|-----|--------|
| SW-PR5015 | 1 1/4" x 31" Colonial | | ea. | \$4.60 |
|-----------|-----------------------|--|-----|--------|